

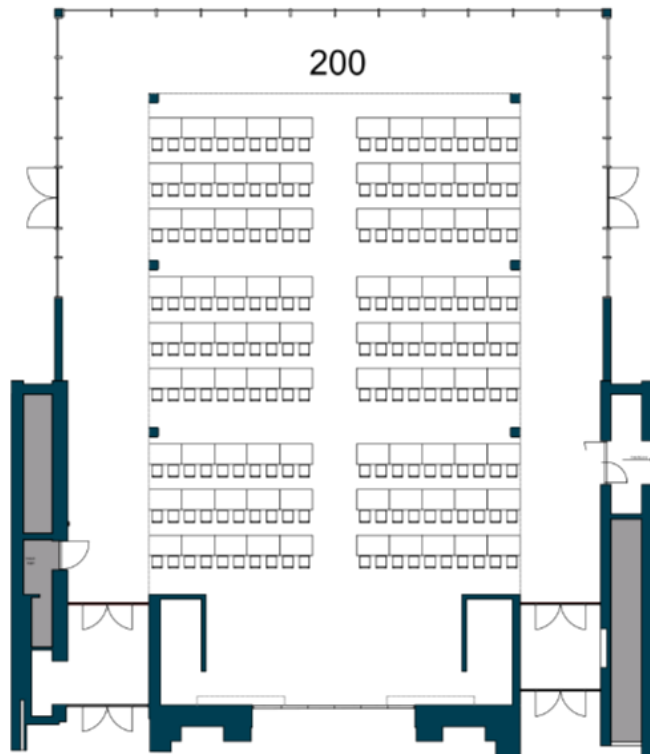

Bestuhlungsplan der Konferenzräume

Kursaal:

Länge: 23,5 m
Breite: 22,5 m
Höhe: 5,4 m
m²: 528 m²



PARLAMENTARISCH
200 Personen

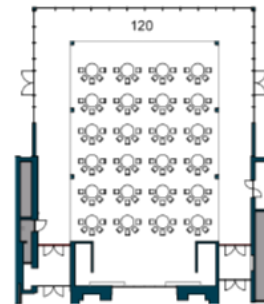

CABARET
120 Personen

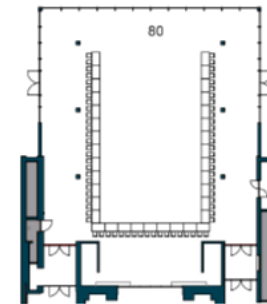

U-FORM
80 Personen

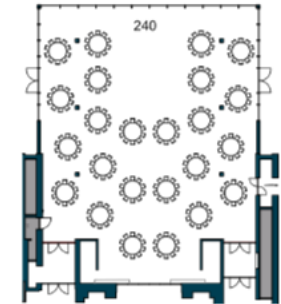

BANKETT
240 Personen

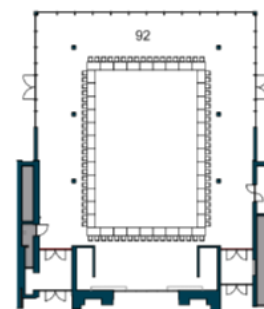

TAFEL
92 Personen

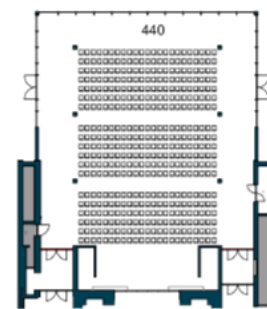

THEATER
440 Personen

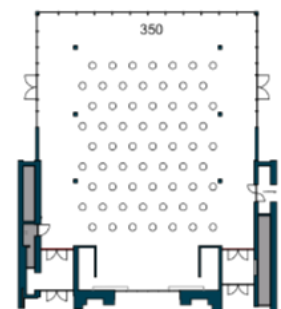

EMPFANG
350 Personen

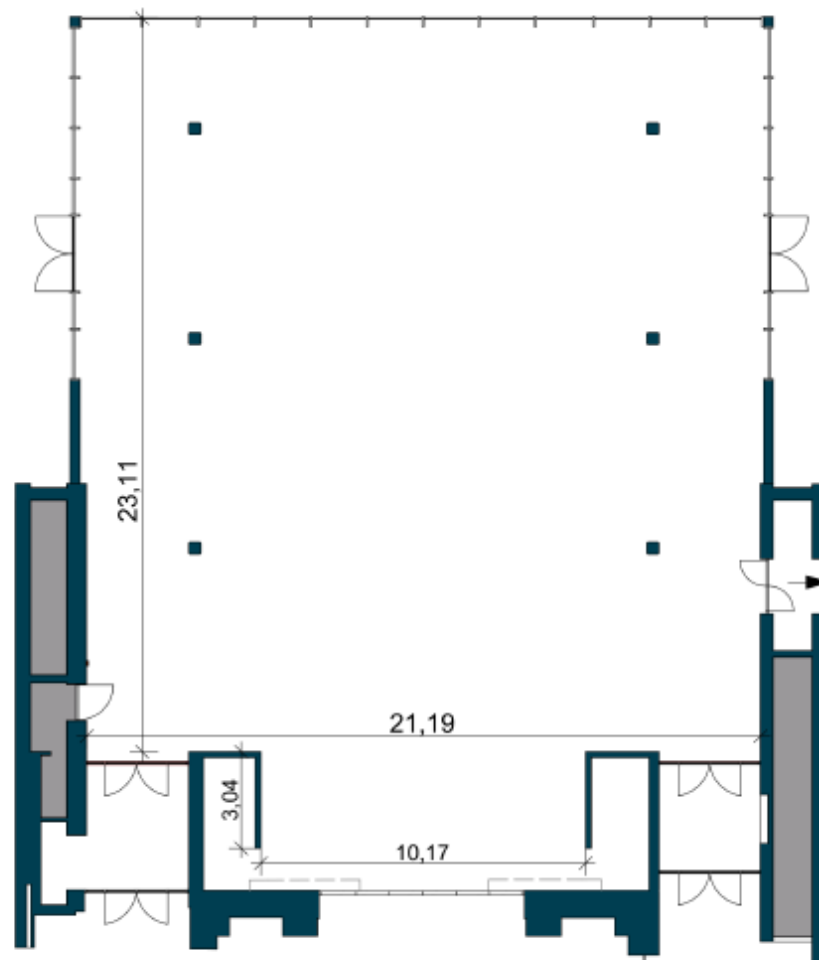

Spiegelsaal :

Länge: 21,5 m
Breite: 10 m
Höhe: 6,1 m
m²: 215 m²

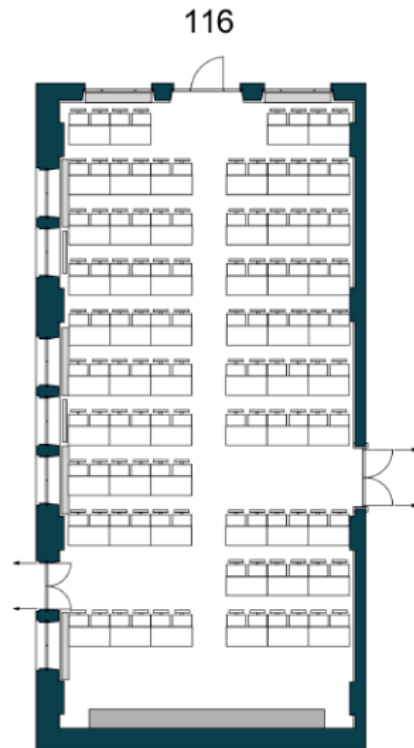

PARLAMENTARISCH
116 Personen

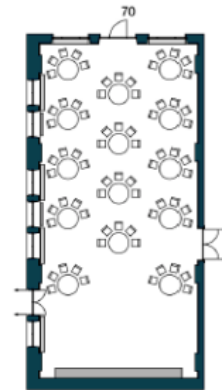

CABARET
70 Personen

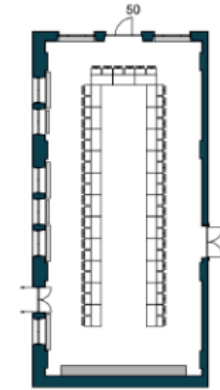

U-FORM
50 Personen

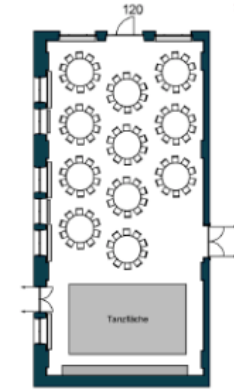

BANKETT
120 Personen

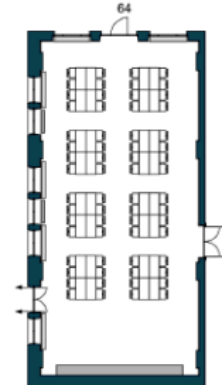

Block
64 Personen

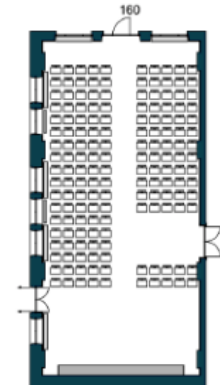

THEATER
160 Personen

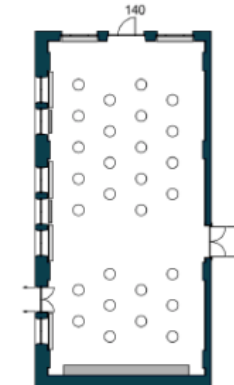

EMPFANG
140 Personen

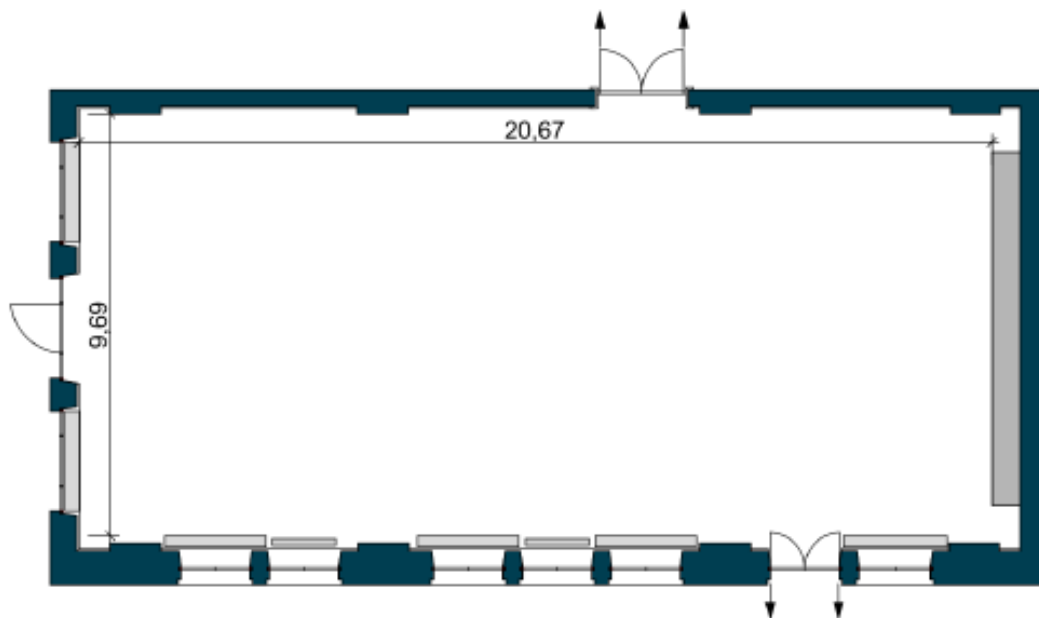

Emporensaal Erdgeschoss:

Länge: 19,1 m
Breite: 10,8 m
Höhe: 8,4 m
m²: 210 m²

Emporensaal 1.Obergeschoss:

Höhe: 3,2 m
m²: 258 m²

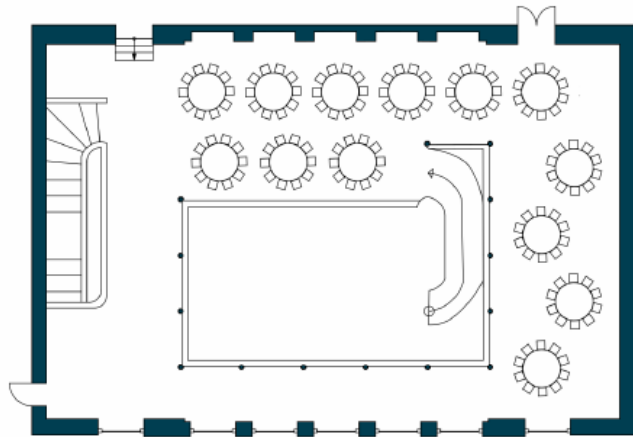

1. OBERGESCHOSS

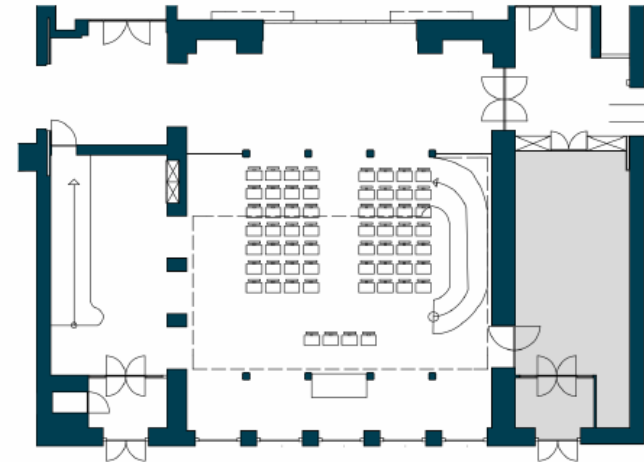

ERDGESCHOSS TRAUUNG

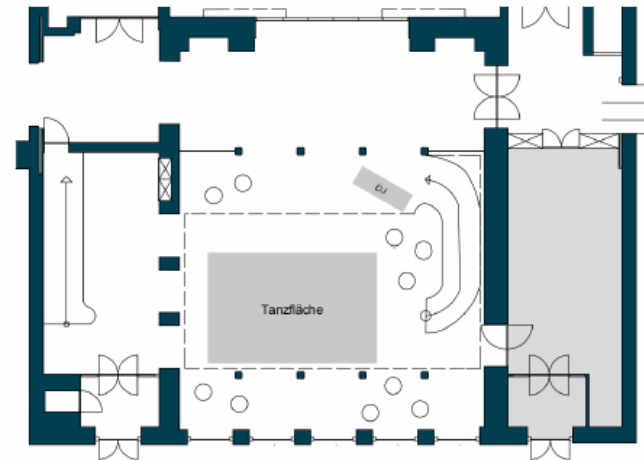

ERDGESCHOSS PARTY

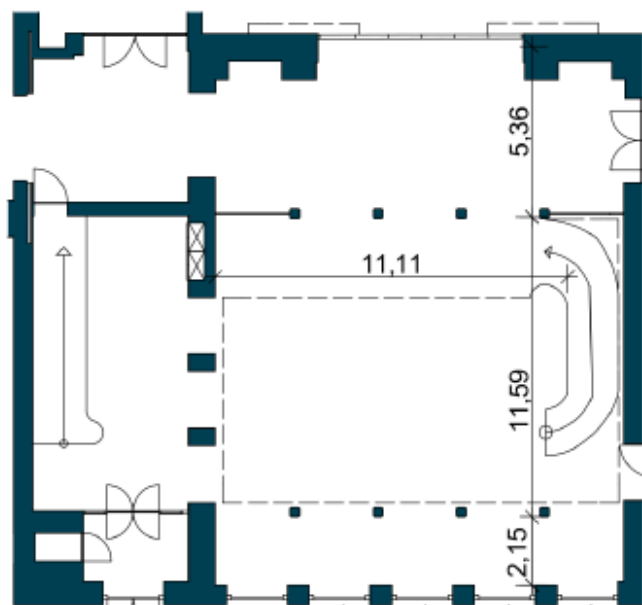

ERDGESCHOSS

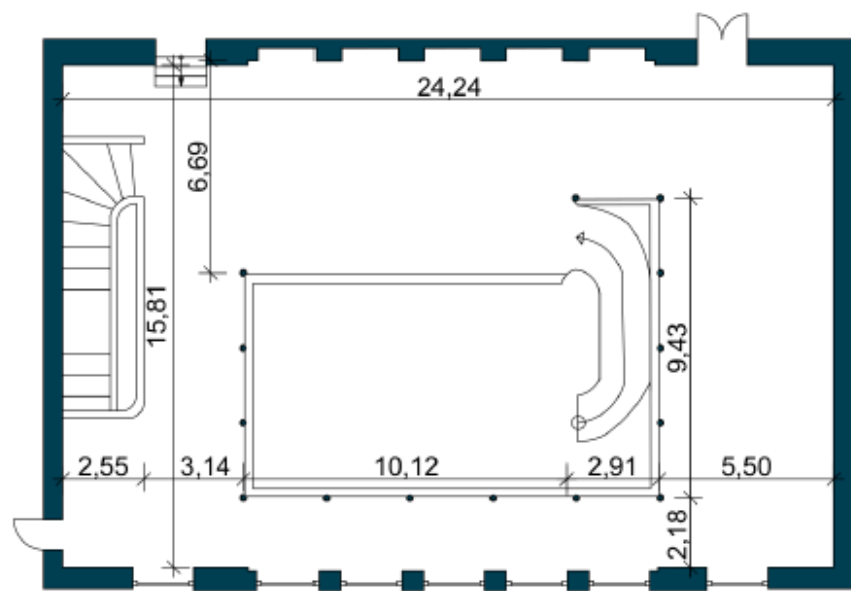

1. OBERGESCHOSS

Parksaal:

Länge: 17 m
Breite: 7,5 m
Höhe: 6,2 m
m²: 128 m²

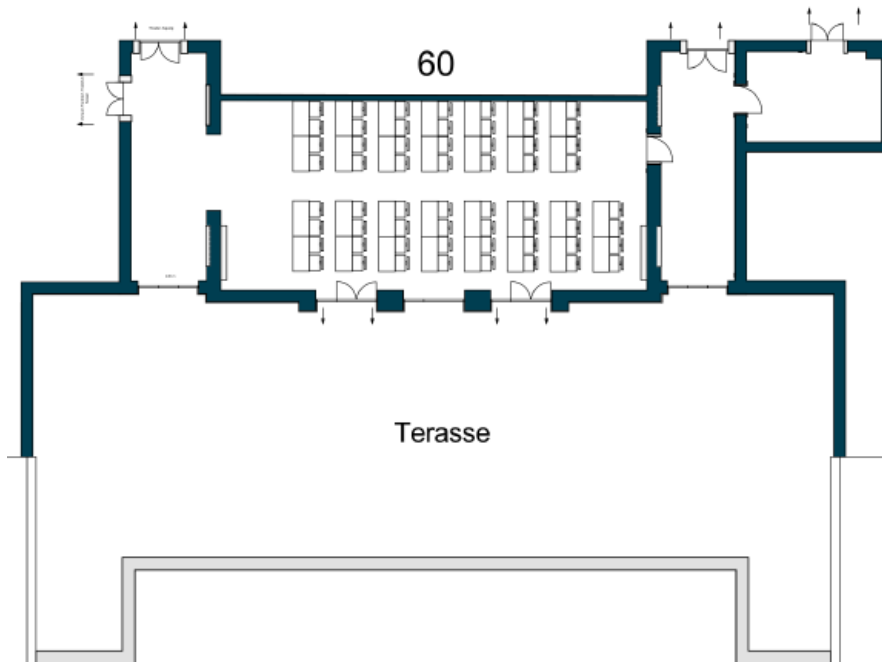

PARLAMENTARISCH
60 Personen

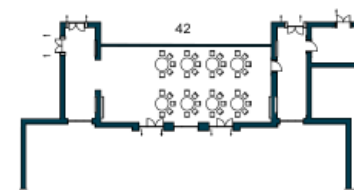

CABARET
42 Personen

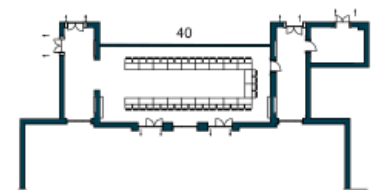

U-FORM
40 Personen

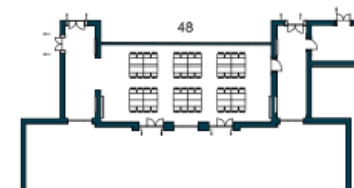

BLOCK
48 Personen

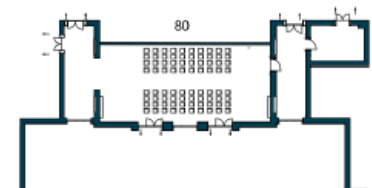

THEATER
80 Personen

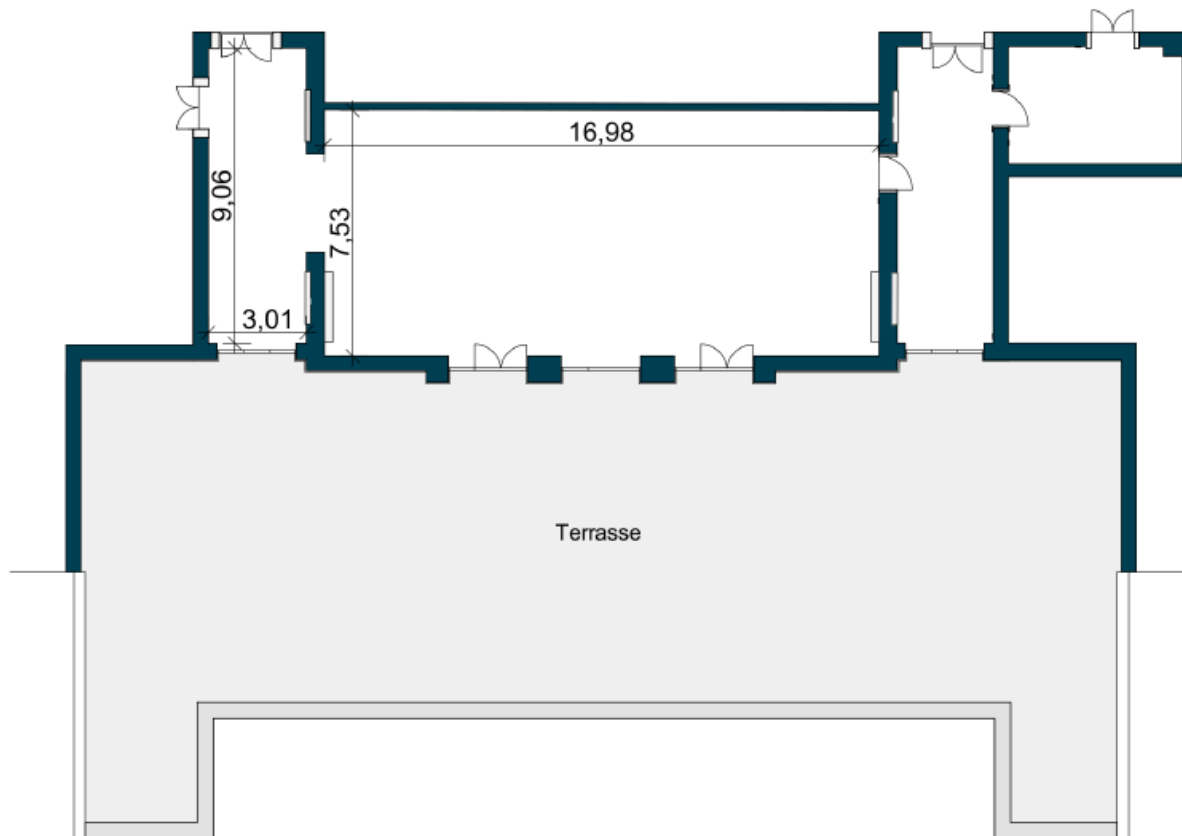

Wiesbaden 1/2:

Länge: 10,5 m
Breite: 9,7 m
Höhe: 3 m
m²: 102 m²

Wiesbaden 1+2:

Länge: 21 m
Breite: 9,7 m
Höhe: 3 m
m²: 204 m²

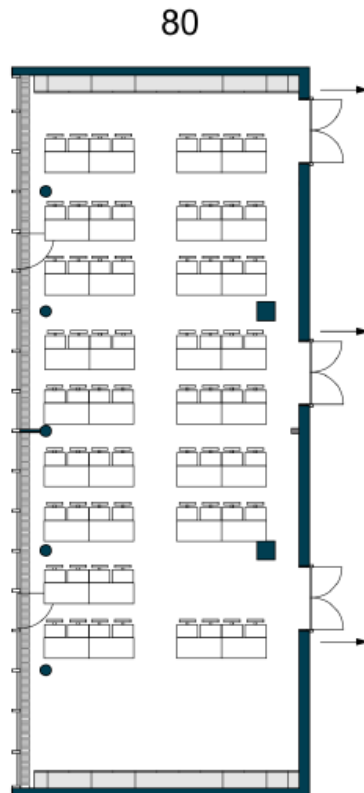

PARLAMENTARISCH
80 Personen

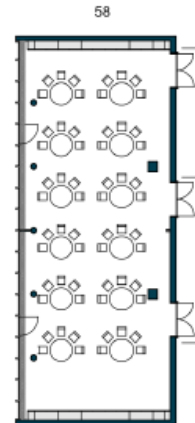

CABARET
58 Personen

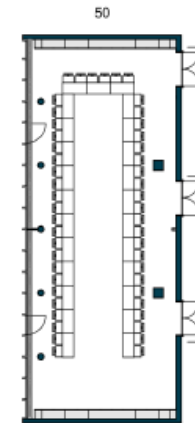

U-FORM
50 Personen

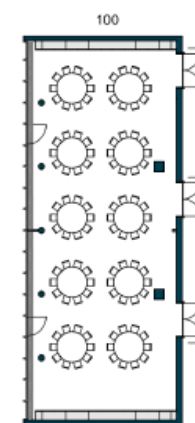

BANKETT
100 Personen

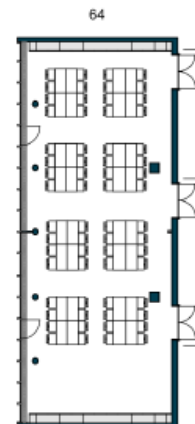

BLOCK
64 Personen



THEATER
120 Personen

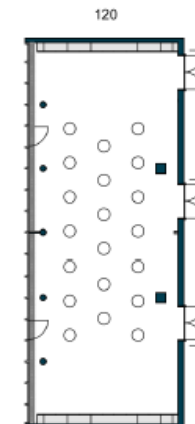

EMPFANG
120 Personen

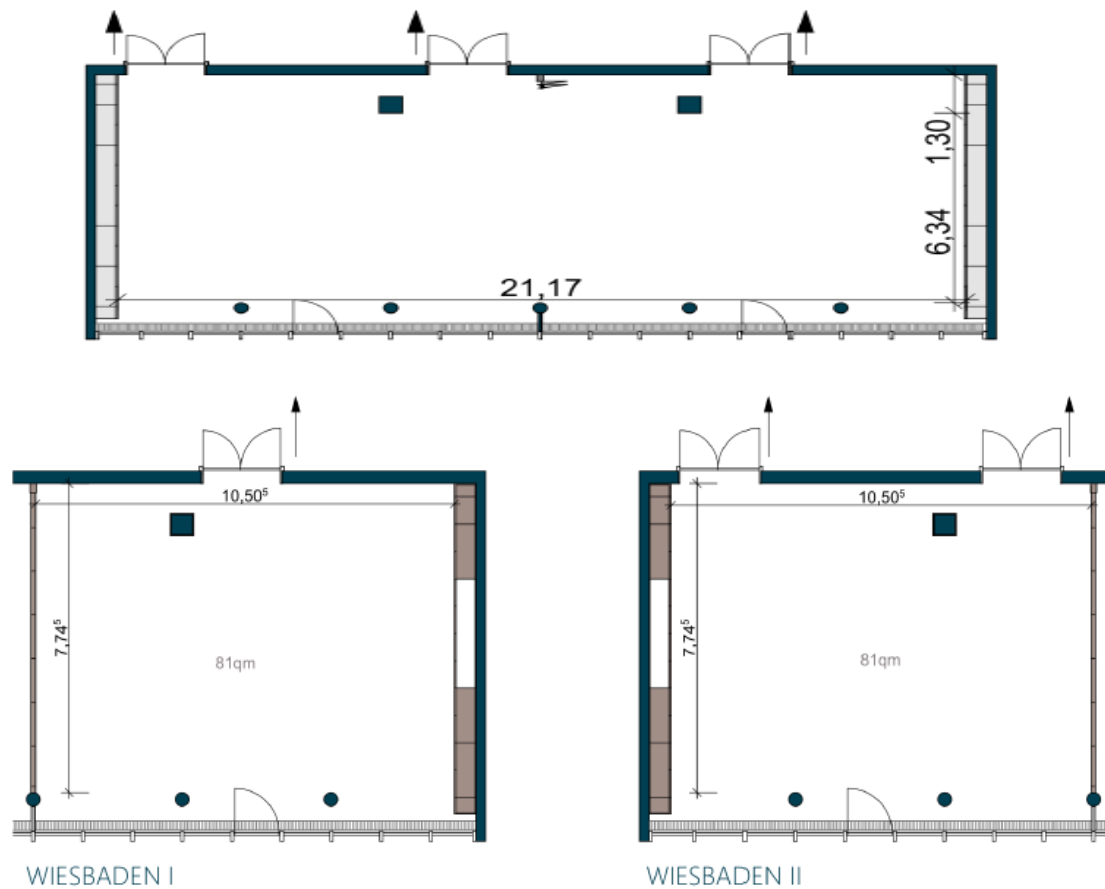

Berlin 1+2:

Länge: 20,5 m
Breite: 8,6 m
Höhe: 3,2 m
m²: 200 m²

68

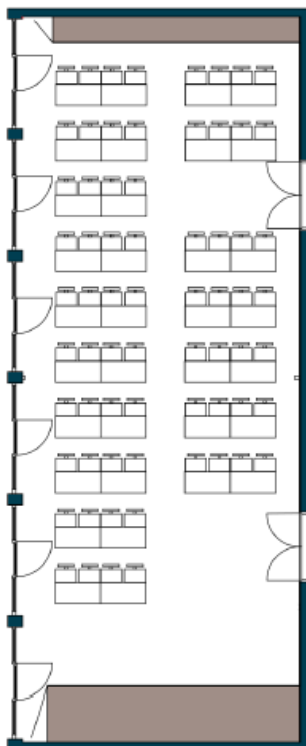

PARLAMENTARISCH
68 Personen

50

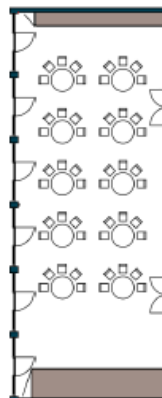

CABARET
50 Personen

50

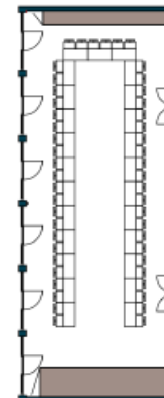

U-FORM
50 Personen

100

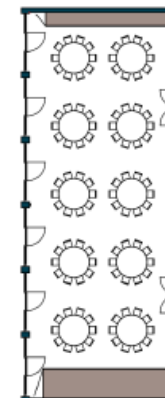

BANKETT
100 Personen

64

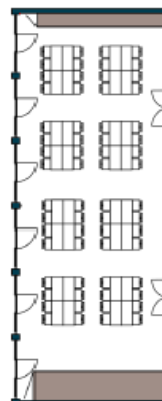

BLOCK
64 Personen

120

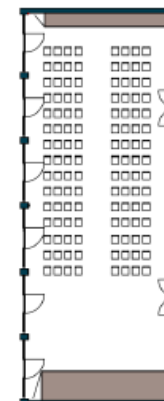

THEATER
120 Personen

100

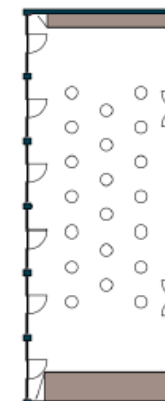

EMPFANG
100 Personen

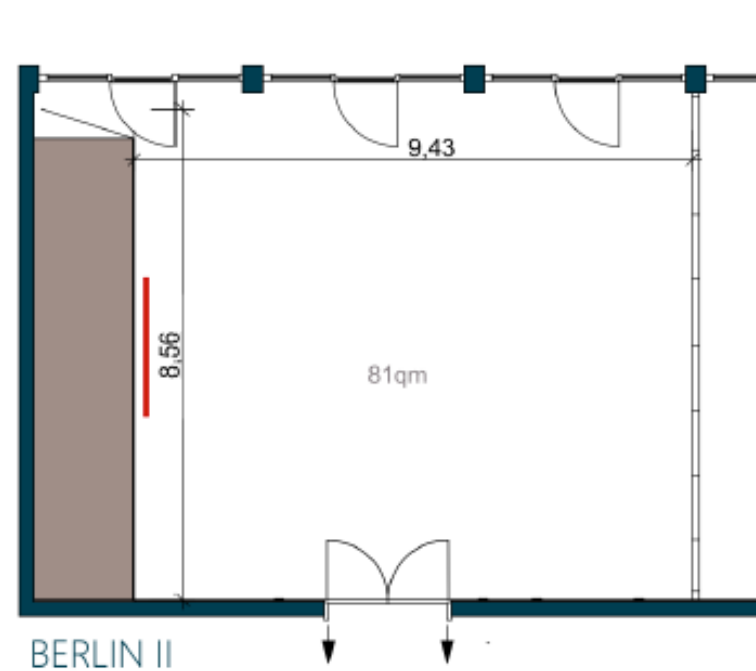
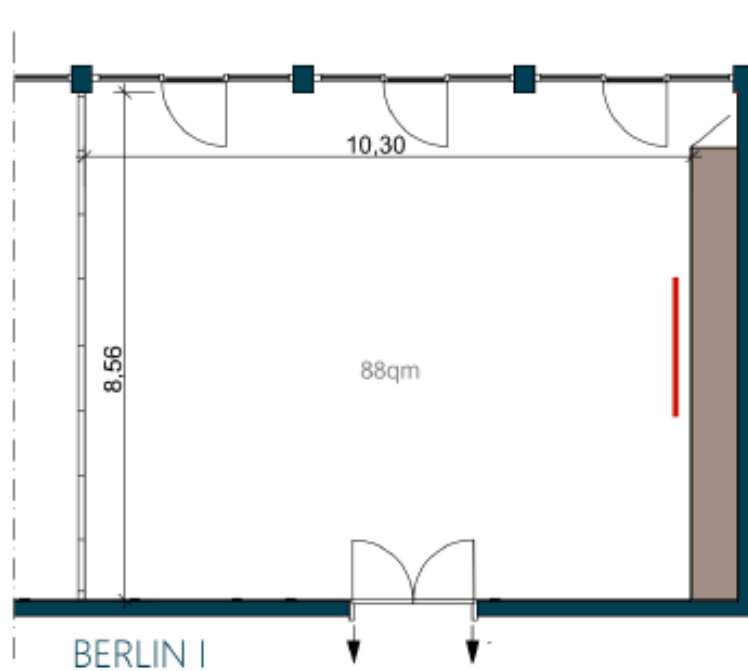

Sprudelhof:

Länge: 11,3 m
Breite: 8,9 m
Höhe: 5,3 m
m²: 100 m²

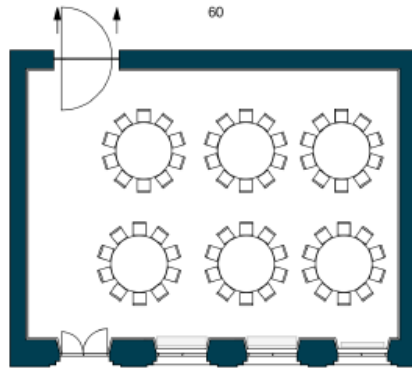

BANKETT
60 Personen

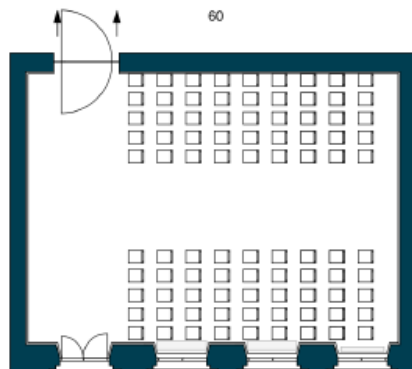

60 Personen
THEATER

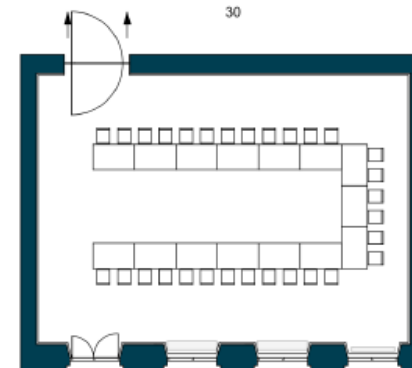

U-FORM
30 Personen

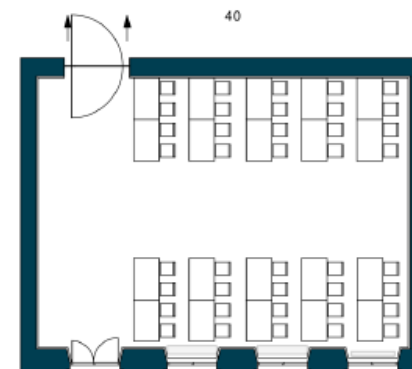

40 Personen
PARLAMENTARISCH

Sprudelhof / Kleiner Salon

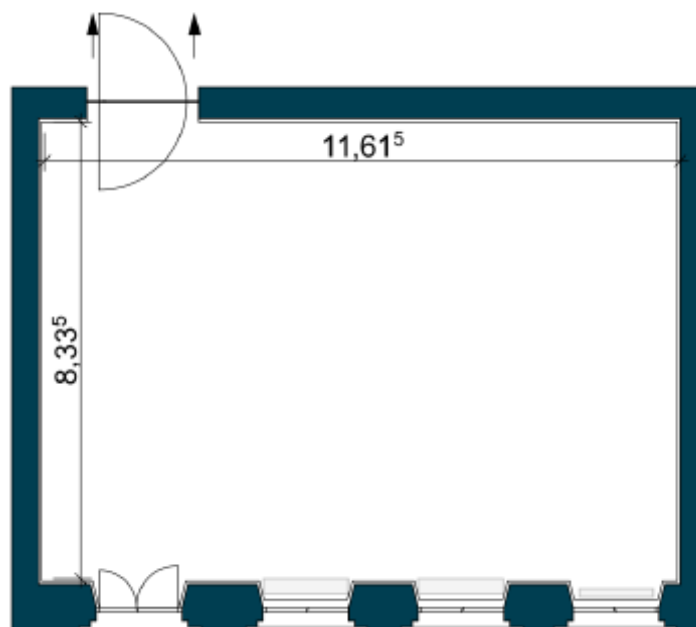

SPRUDELHOF

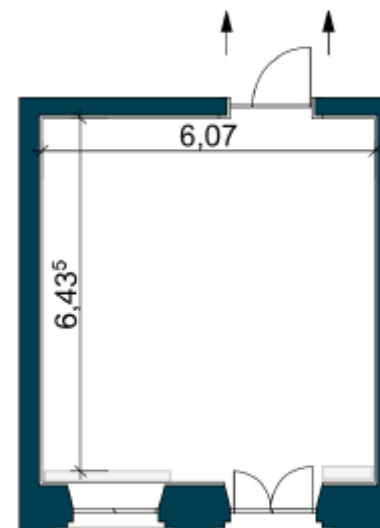

KLEINER SALON

Bad Nauheim

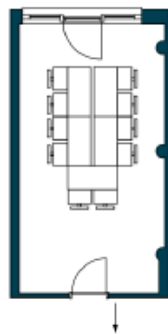

BLOCK BAD NAUHEIM II
10 Personen



THEATER BAD NAUHEIM IV
Bieten wir nicht an?



PARLAMENTARISCH BAD NAUHEIM I
10 Personen

Bad Nauheim 1:

Länge: 4,4 m
Breite: 9,6 m
Höhe: 3,3 m
m²: 42 m²

Bad Nauheim 2:

Länge: 3,8 m
Breite: 7,8 m
Höhe: 3,3 m
m²: 30 m²

Bad Nauheim 3:

Länge: 3,8 m
Breite: 7,2 m
Höhe: 3,3 m
m²: 27 m²

Bad Nauheim 4:

Länge: 3,8 m
Breite: 7,2 m
Höhe: 3,3 m
m²: 27 m²

Bad Nauheim 5:

Länge: 3,4 m
Breite: 7,2 m
Höhe: 3,3 m
m²: 25 m²

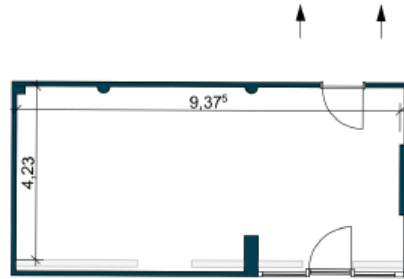

BAD NAUHEIM I



BAD NAUHEIM II



BAD NAUHEIM III



BAD NAUHEIM IV



BAD NAUHEIM V

Bonn:

Länge: 11,2 m
Breite: 7,2 m
Höhe: 3,3 m
m²: 81 m²

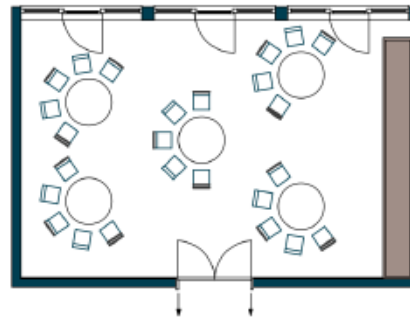

CABARET BONN
18 Personen

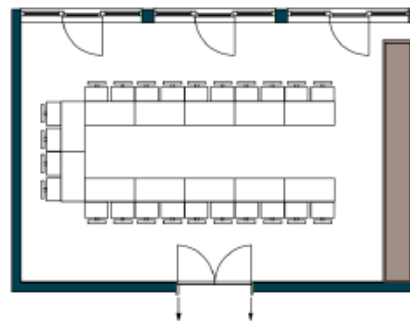

U-FORM BONN
20 Personen

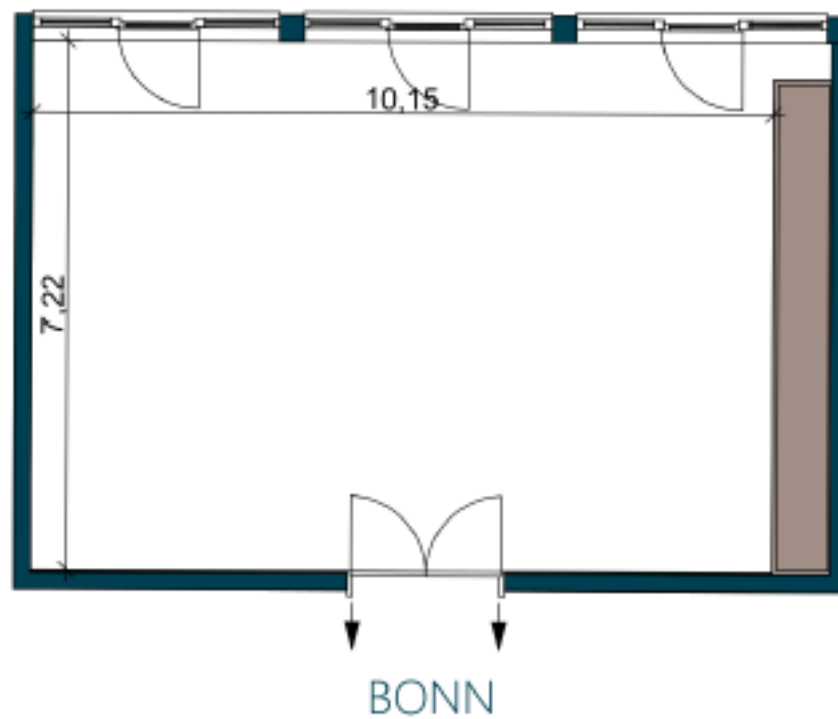

Bad Homburg

Länge: 14,65 m
Breite: 8,4 m
Höhe: 3,8 m
m²: 123 m²

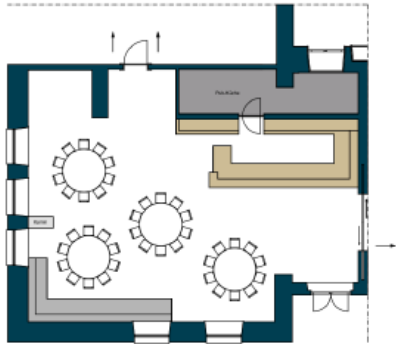

BANKETT
120 Personen

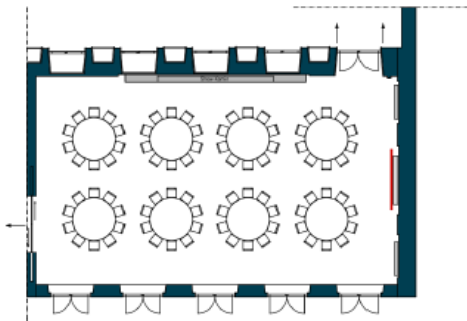

BANKETT
120 Personen

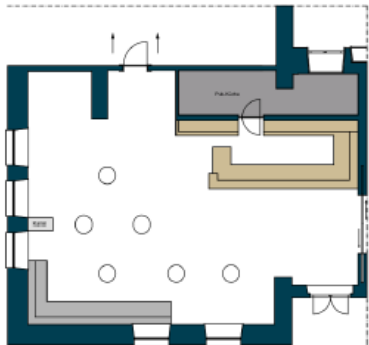

EMPFANG
120 Personen

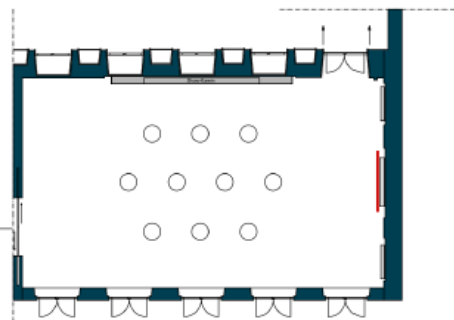

EMPFANG
120 Personen

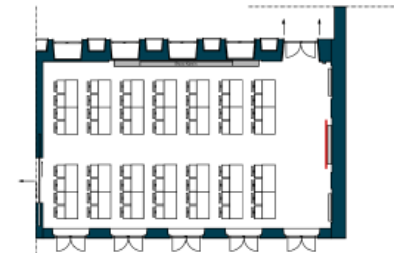

PARLAMENTARISCH
60 Personen

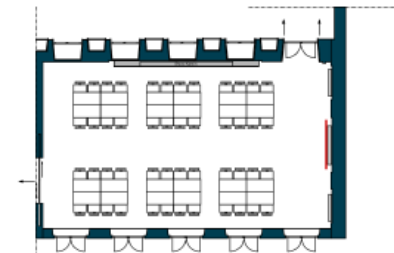

BLOCK
64 Personen

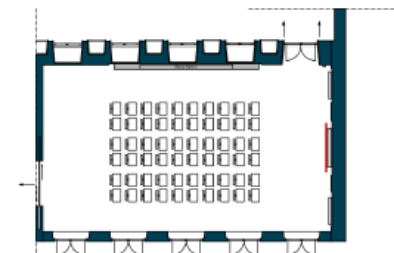

THEATER
80 Personen

Pub:

Länge: 13,77 m
Breite: 10,9 m
Höhe: 3 m
m²: 150 m²

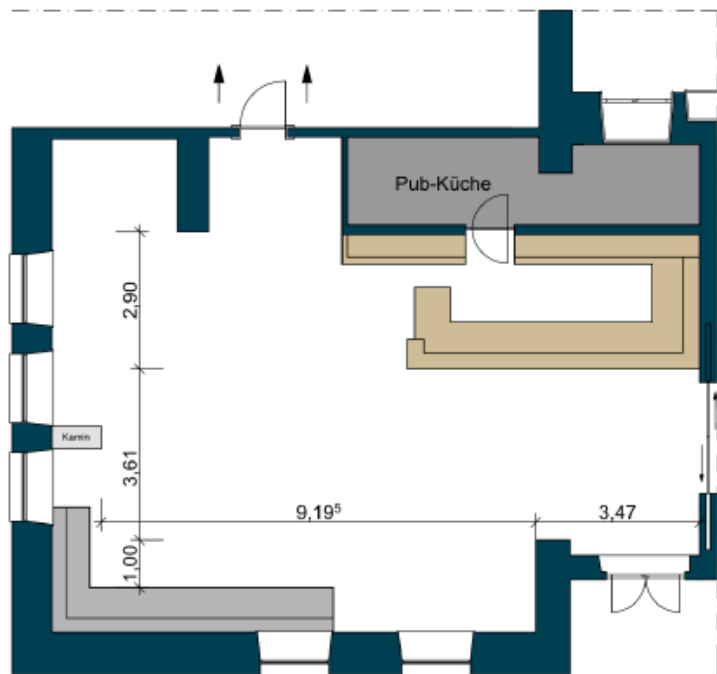

MAHONYS PUB

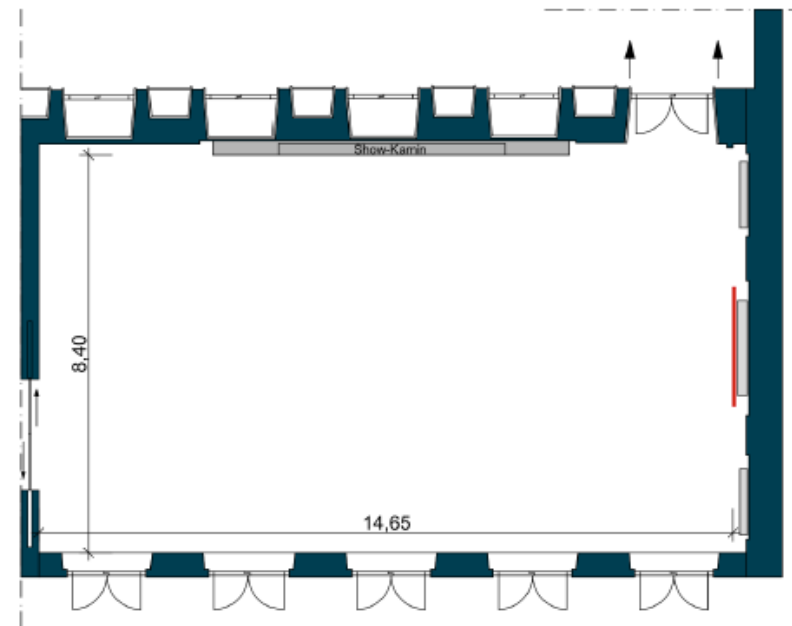

BAD HOMBURG

Mainz 1/2:

Länge: 7,3 m
Breite: 3,5 m
Höhe: 3 m
m²: 26 m²

London:

Länge: 7,3 m
Breite: 7,3 m
Höhe: 3 m
m²: 53 m²

Paris:

Länge: 7,3 m
Breite: 7,3 m
Höhe: 3 m
m²: 53 m²

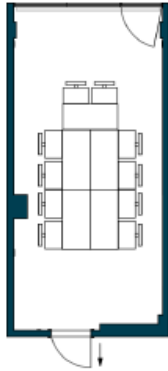

BLOCK MAINZ I

10 Personen

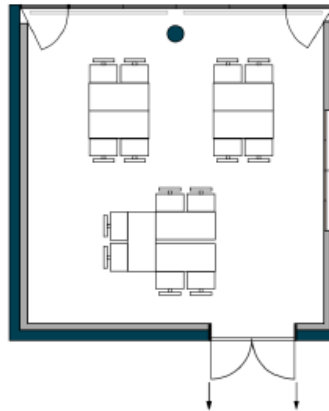

BLOCK LONDON

14 Personen

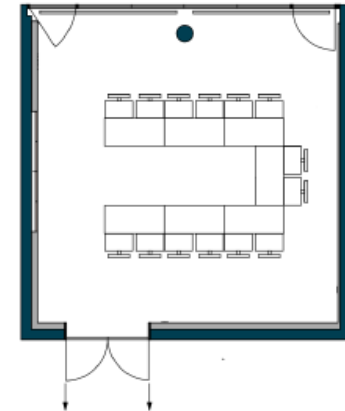

U-FORM PARIS

14 Personen



12 Personen

THEATER MAINZ II



20 Personen

PARLAMENTARISCH LONDON

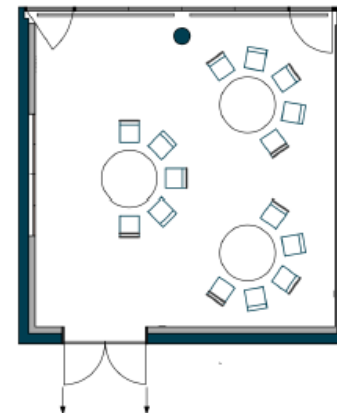

CABARET PARIS

15 Personen



MAINZ I

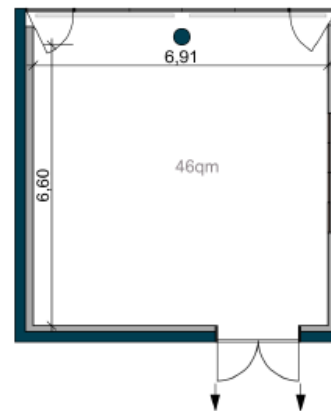

LONDON



MAINZ II

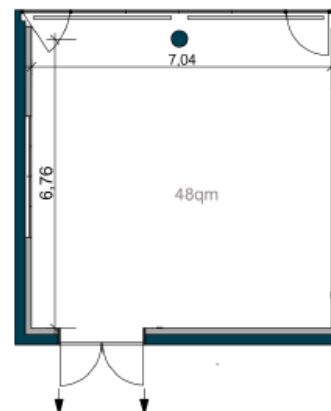

PARIS

Frankfurt:

Länge: 9,10 m
Breite: 7,5 m
Höhe: 3,6 m
m²: 68 m²

Kassel:

Länge: 8,60 m
Breite: 5,8 m
Höhe: 3,6 m
m²: 50 m²

Gießen:

Länge: 10,80 m
Breite: 6 m
Höhe: 3,6 m
m²: 65 m²

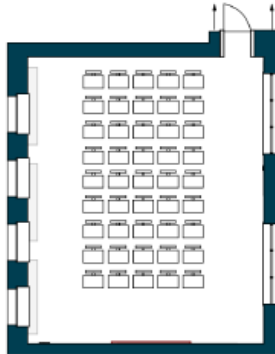

THEATER FRANKFURT
50 Personen

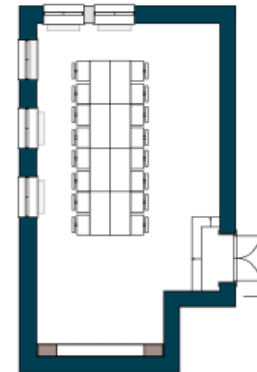

BLOCK KASSEL
16 Personen

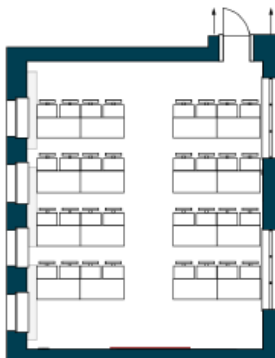

PARLAMENTARISCH FRANKFURT
32 Personen

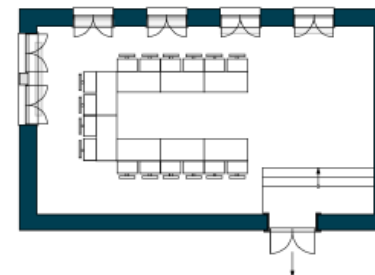

U-FORM GIEßEN
24 Personen

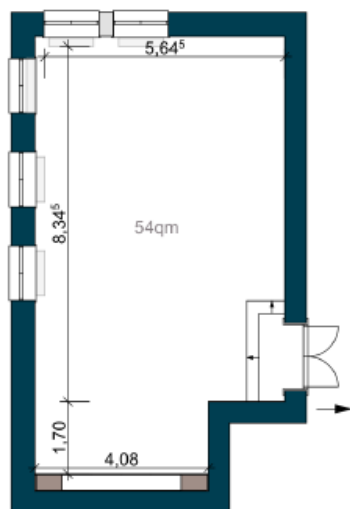

KASSEL

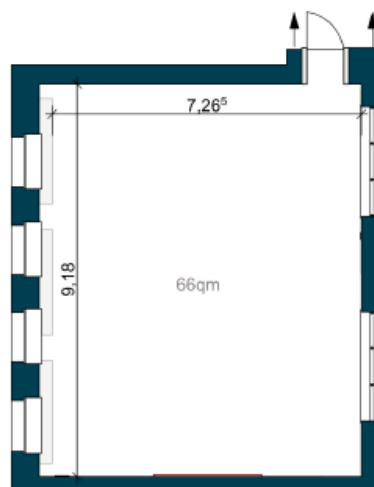

FRANKFURT

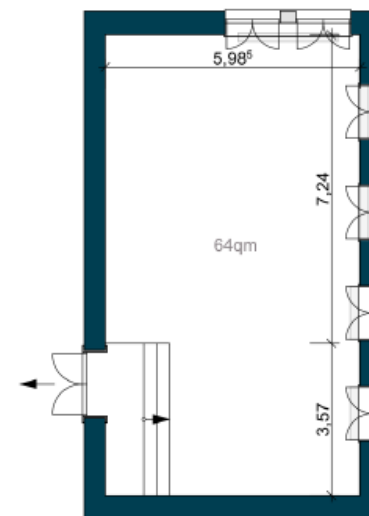

GIEBEN